

TOSHIBA Photocoupler Photorelay

# TLP3120

High-Speed Memory Tester  
 High-Speed Logic Tester  
 High-Frequency Measurement Equipment

The Toshiba TLP3120 consists of an aluminum gallium arsenide infrared emitting diode optically coupled to a photo-MOSFET in a SOP, which is suitable for surface mount assembly.

- 6-pin SOP (2.54SOP6): 2.1 mm high, 2.54 mm pitch
- Normally opened (form A) device
- Peak OFF-state voltage: 80 V (min)
- Trigger LED current: 5 mA (max)
- ON-state current: 1.25 A (max)
- ON-state resistance: 0.15 Ω (max)
- Capacitance: 1000 pF (max)
- Isolation voltage: 1500 V<sub>rms</sub> (min)

### Pin Configuration (top view)

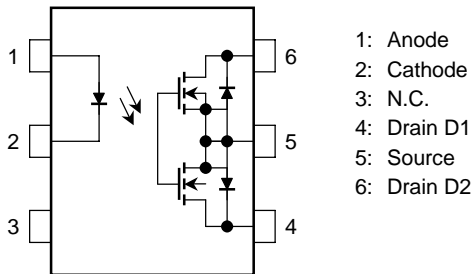

Unit: mm

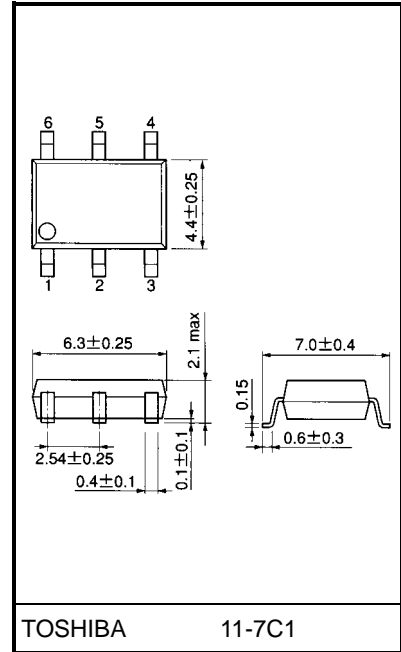

Weight: 0.13 g (typ.)

## Maximum Ratings (Ta = 25°C)

Characteristics		Symbol	Rating	Unit
Led	Forward current	$I_F$	50	mA
	Forward current derating (Ta ≥ 25°C)	$\Delta I_F/^\circ\text{C}$	-0.5	mA/°C
	Reverse voltage	$V_R$	5	V
	Junction temperature	$T_j$	125	°C
Detector	OFF-state output terminal voltage	$V_{OFF}$	80	V
	ON-state current	$I_{ON}$	1.25	A
	ON-state current derating (Ta ≥ 25°C)	$\Delta I_{ON}/^\circ\text{C}$	-12.5	mA/°C
	Junction temperature	$T_j$	125	°C
Storage temperature range		$T_{stg}$	-40~125	°C
Operating temperature range		$T_{opr}$	-20~85	°C
Lead soldering temperature (10 s)		$T_{sol}$	260	°C
Isolation voltage (AC, 1 min, R.H. ≤ 60%) (Note 1)		$BV_s$	1500	Vrms

Note 1: Device is considered as a two-terminal device. LED side pins are shorted together and detector side pins are shorted together.

## Recommended Operating Conditions

Characteristics	Symbol	Min	Typ.	Max	Unit
Supply voltage	$V_{DD}$	—	—	64	V
Forward current	$I_F$	5	—	30	mA
ON-state current	$I_{ON}$	—	—	1.25	A
Operating temperature	$T_{opr}$	25	—	60	°C

## Individual Electrical Characteristics (Ta = 25°C)

Characteristics		Symbol	Test Condition	Min	Typ.	Max	Unit
Led	Forward current	$V_F$	$I_F = 10 \text{ mA}$	1.0	1.15	1.3	V
	Reverse current	$I_R$	$V_R = 5 \text{ V}$	—	—	10	μA
	Capacitance	$C_T$	$V = 0, f = 1 \text{ MHz}$	—	15	—	pF
Detector	OFF-state current	$I_{OFF}$	$V_{OFF} = 20 \text{ V}, T_a = 50^\circ\text{C}$	—	1200	1500	pA
	Capacitance	$C_{OFF}$	$V = 0, f = 100 \text{ MHz}$	—	460	1000	pF

## Coupled Electrical Characteristics (Ta = 25°C)

Characteristics	Symbol	Test Condition	Min	Typ.	Max	Unit
Trigger LED current	$I_{FT}$	$I_{ON} = 1.25 \text{ A}$	—	2	5	mA
Return LED current	$I_{FC}$	$I_{OFF} = 10 \mu\text{A}$	0.2	—	—	mA
ON-state resistance	$R_{ON}$	$I_{ON} = 1.25 \text{ A}, I_F = 5 \text{ mA}$	—	0.11	0.15	$\Omega$

## Isolation Characteristics (Ta = 25°C)

Characteristics	Symbol	Test Condition	Min	Typ.	Max	Unit
Capacitance input to output	$C_S$	$V_S = 0 \text{ V}, f = 1 \text{ MHz}$	—	0.8	—	pF
Isolation resistance	$R_S$	$V_S = 500 \text{ V}, \text{R.H.} \leq 60\%$	$5 \times 10^{10}$	$10^{14}$	—	$\Omega$
Isolation voltage	$BV_S$	AC, 1 min	1500	—	—	Vrms
		AC, 1 s (in oil)	—	3000	—	—
		DC, 1 min (in oil)	—	3000	—	Vdc

## Switching Characteristics (Ta = 25°C)

Characteristics	Symbol	Test Condition	Min	Typ.	Max	Unit
Turn-ON time	$t_{ON}$	$R_L = 200 \Omega$	—	2.0	3.0	ms
Turn-OFF time	$t_{OFF}$	$V_{DD} = 20 \text{ V}, I_F = 5 \text{ mA}$ (Note 2)	—	0.7	1.0	

Note 2: Switching time test circuit

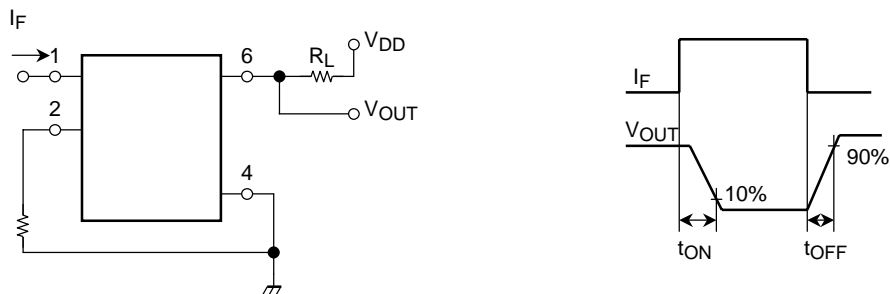

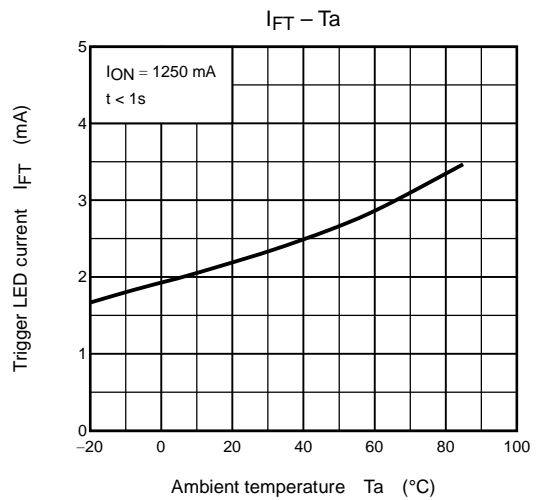
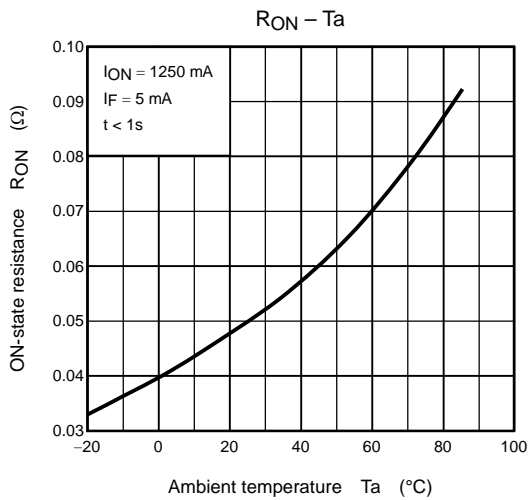
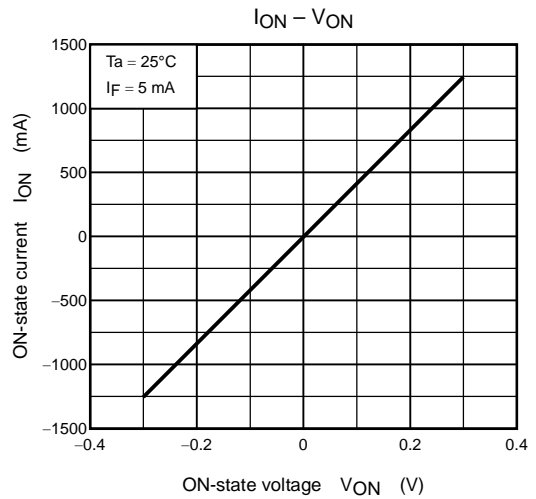
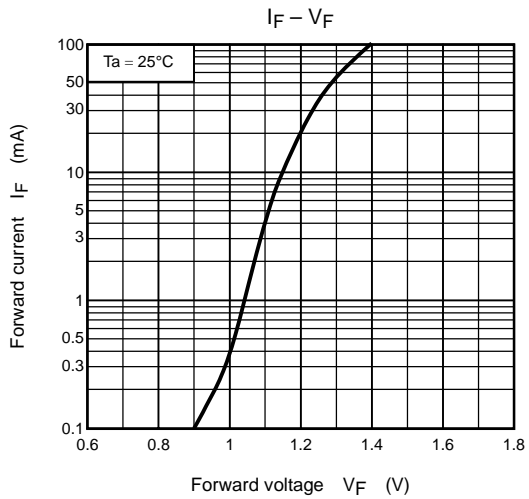
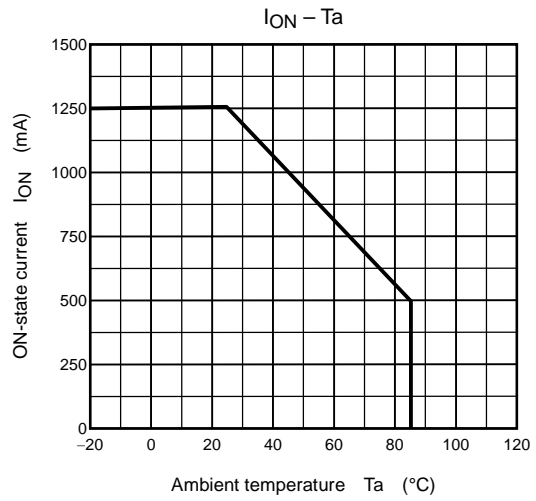
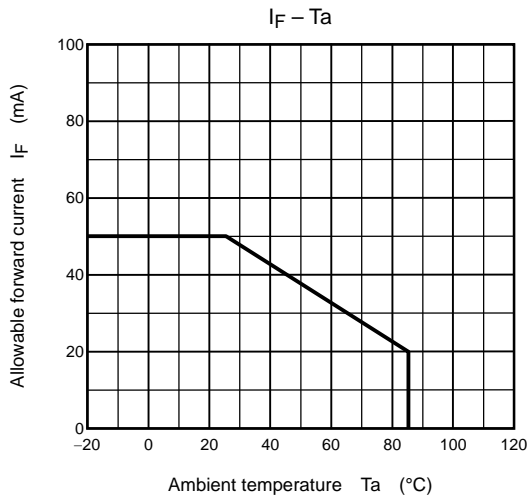

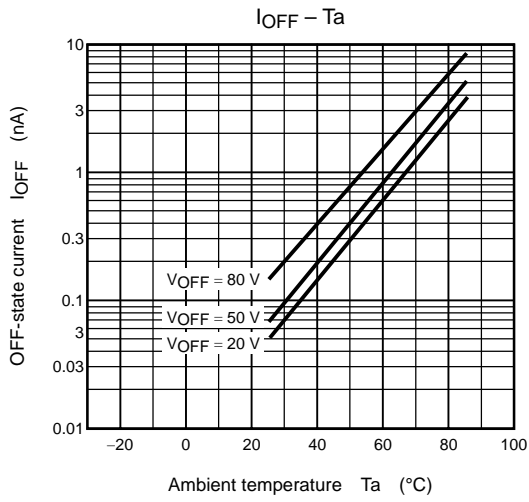
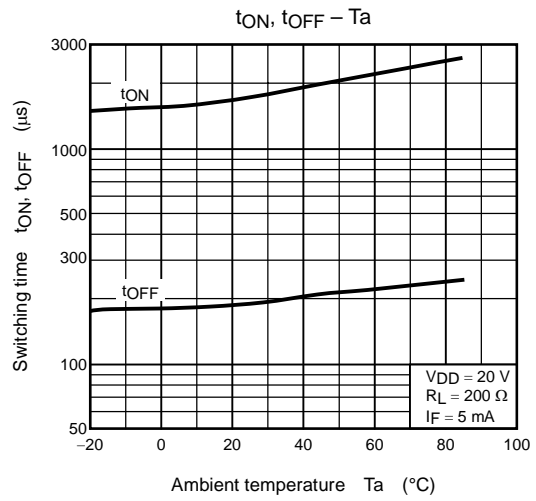
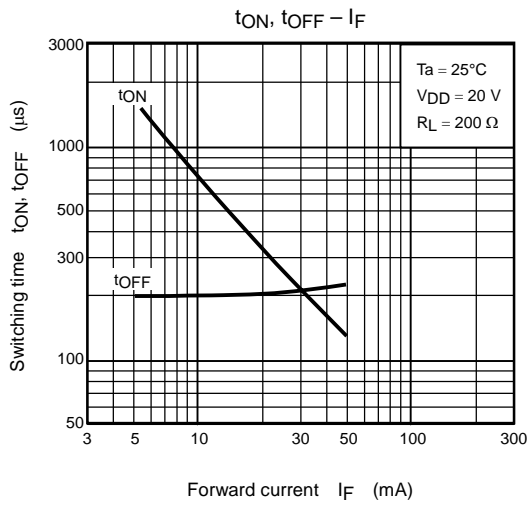

**RESTRICTIONS ON PRODUCT USE**

000707EBC

- TOSHIBA is continually working to improve the quality and reliability of its products. Nevertheless, semiconductor devices in general can malfunction or fail due to their inherent electrical sensitivity and vulnerability to physical stress. It is the responsibility of the buyer, when utilizing TOSHIBA products, to comply with the standards of safety in making a safe design for the entire system, and to avoid situations in which a malfunction or failure of such TOSHIBA products could cause loss of human life, bodily injury or damage to property.  
In developing your designs, please ensure that TOSHIBA products are used within specified operating ranges as set forth in the most recent TOSHIBA products specifications. Also, please keep in mind the precautions and conditions set forth in the "Handling Guide for Semiconductor Devices," or "TOSHIBA Semiconductor Reliability Handbook" etc..
- The TOSHIBA products listed in this document are intended for usage in general electronics applications (computer, personal equipment, office equipment, measuring equipment, industrial robotics, domestic appliances, etc.). These TOSHIBA products are neither intended nor warranted for usage in equipment that requires extraordinarily high quality and/or reliability or a malfunction or failure of which may cause loss of human life or bodily injury ("Unintended Usage"). Unintended Usage include atomic energy control instruments, airplane or spaceship instruments, transportation instruments, traffic signal instruments, combustion control instruments, medical instruments, all types of safety devices, etc.. Unintended Usage of TOSHIBA products listed in this document shall be made at the customer's own risk.
- Gallium arsenide (GaAs) is a substance used in the products described in this document. GaAs dust and fumes are toxic. Do not break, cut or pulverize the product, or use chemicals to dissolve them. When disposing of the products, follow the appropriate regulations. Do not dispose of the products with other industrial waste or with domestic garbage.
- The products described in this document are subject to the foreign exchange and foreign trade laws.
- The information contained herein is presented only as a guide for the applications of our products. No responsibility is assumed by TOSHIBA CORPORATION for any infringements of intellectual property or other rights of the third parties which may result from its use. No license is granted by implication or otherwise under any intellectual property or other rights of TOSHIBA CORPORATION or others.
- The information contained herein is subject to change without notice.